

KENCO ENGINEERING COMPANY

P.O. BOX 470426 TULSA, OK 74147-0426 • PHONE: (918) 663-4406 FAX: (918) 663-4480
www.kenco-eng.com e-mail: info@kenco-eng.com

MODEL KPFS PNEUMATIC FLOAT SWITCH INSTALLATION / OPERATION INSTRUCTIONS

(U.S. Patent #'s 9,046,190 and 8,564,390)

PRINCIPLE OF OPERATION

The Model KPFS uses a float to determine the presence or absence of liquid at the process connection. The float arm assembly consists of a float at one end and a magnet at the other. As the level rises, the float rises, and the magnet falls. The magnet actuates a second magnet on the other side of the pressure boundary. This second magnet is the reactive component in the snap acting switch that opens and closes the pneumatic valve. Because of the nature of the design, adjustment is rarely, if ever needed. In the event that adjustment is needed, an easy to use adjustable needle valve seat is provided. The model KPFS is used to actuate pneumatic dump valves, such as the Kenco model KDV series dump valve, to control the liquid level in separators, scrubbers, etc.

The pressure boundary contains no seals; it is a solid stainless steel barrier that passes a magnetic field, but no liquids. It is impossible for the process liquid to enter the switch enclosure through this barrier.

The Model KPFS Pneumatic Float Switch can be ordered to have the pneumatic valve open when it senses a liquid level rising (-LR option) or open when it senses the liquid level falling (-LF option). A manual actuator is provided to open valve manually if desired. An optional Test Button is available that will cycle the Switch Float, testing the proper operation of the Float and its interaction with the switch mechanism and valve. The Test Button can only lift (raise) the Float, therefore the Float must be in the down or lowered position (liquid level below the KPFS connection) in order for the Test Button to properly cycle the Float. See the Test Button Installation and Operation Manual for more details.

SWITCH MODEL	FLOAT POSITION	VALVE STATE
KPFS-LR	DOWN	CLOSED
KPFS-LR	UP	OPEN
KPFS-LF	DOWN	OPEN
KPFS-LF	UP	CLOSED

STANDARD KPFS

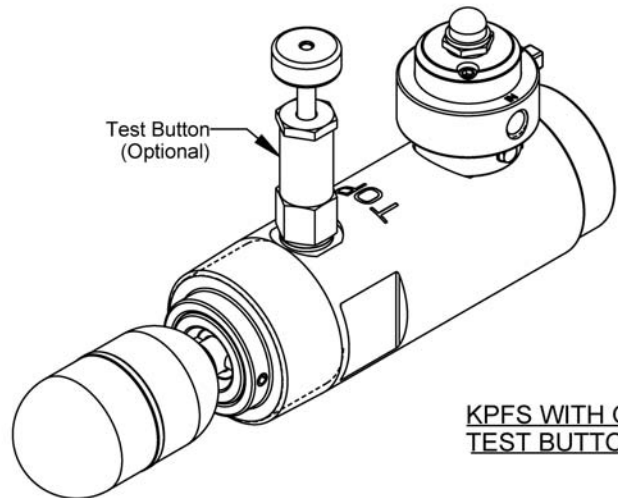
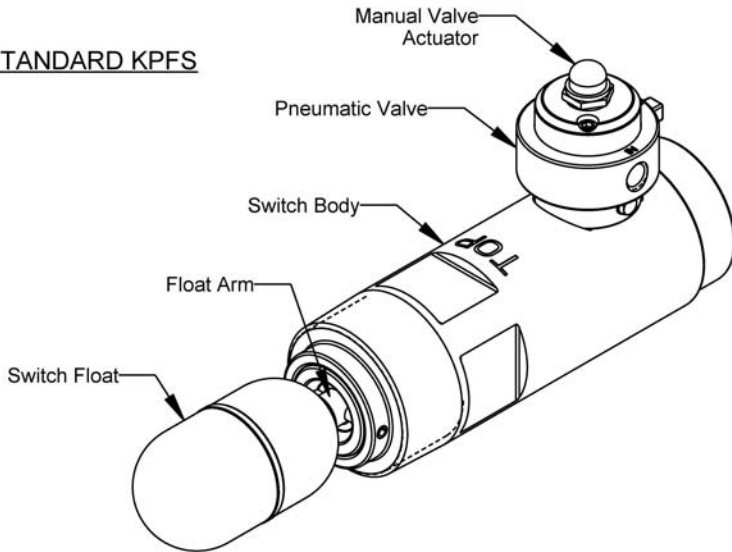

KPFS WITH OPTIONAL TEST BUTTON

ORDERING SYSTEM

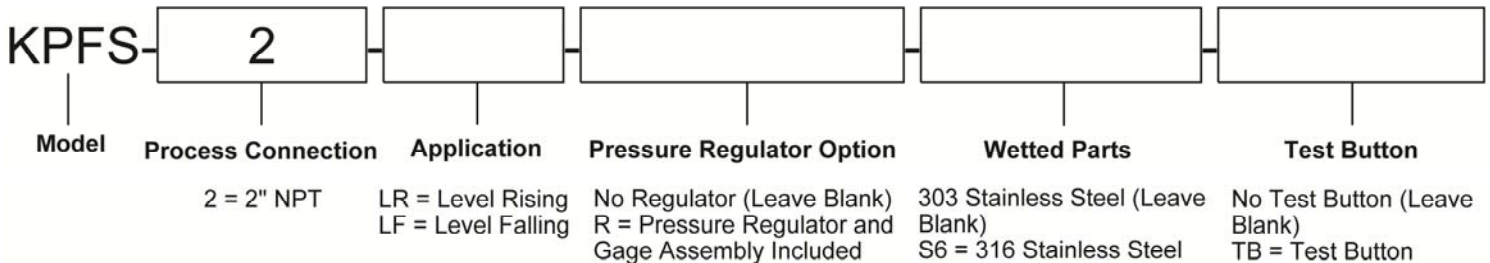

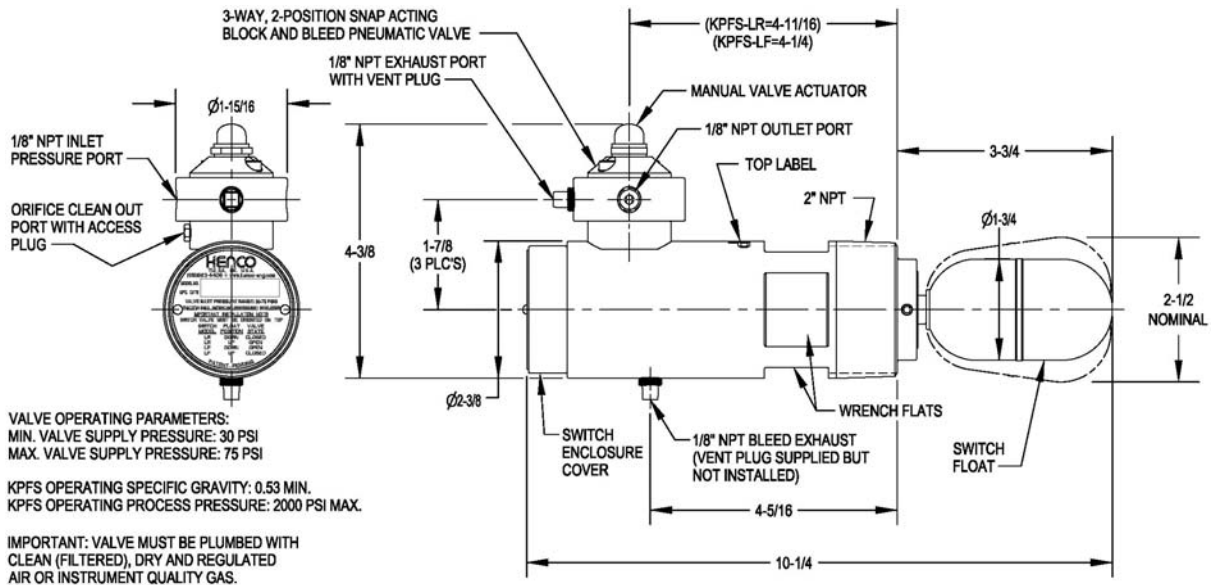

KPFS WITHOUT “-R” PRESSURE REGULATOR AND GAGE OPTION

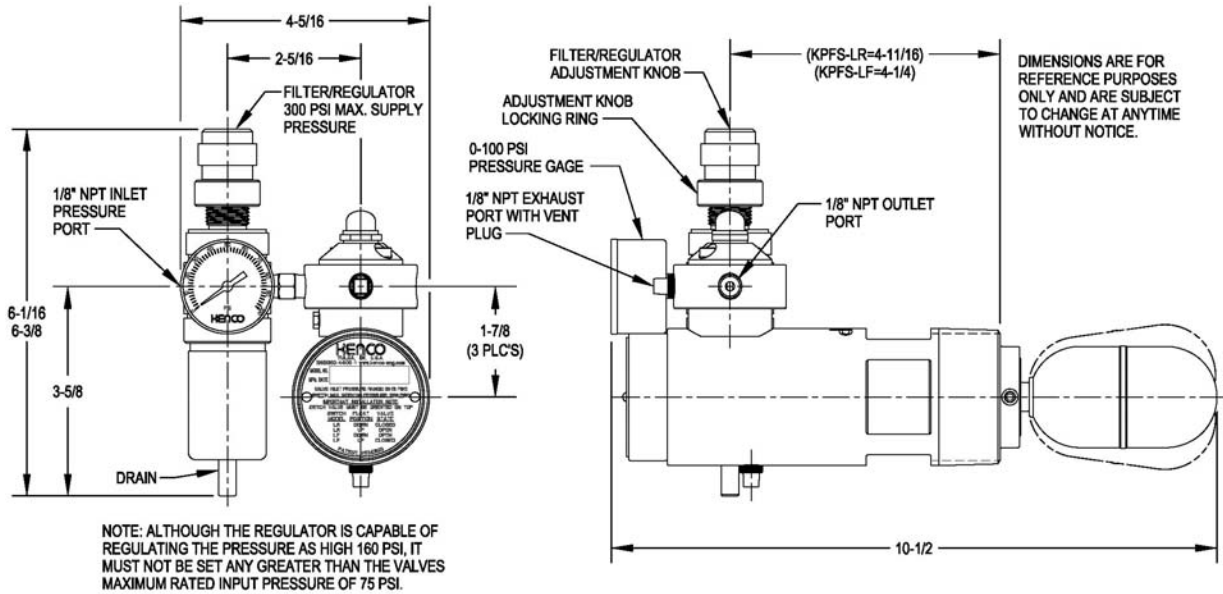

KPFS WITH “-R” PRESSURE REGULATOR AND GAGE OPTION

INSTALLATION

Unpack the switch carefully. Inspect the unit(s) for damage. Report any damage to carrier immediately. Check the contents against the packing slip and purchase order.

Mounting

1. The Switch Float comes uninstalled. This gives you the option of installing the Switch Float with or without the included 11/16" long Switch Float Extension. **Note: Using the included 11/16" long Switch Float Extension will raise the minimum operating specific gravity of the KPFS from 0.53 to 0.66.**
2. Make sure the movement of the float will not be obstructed by the coupling, vessel wall or other vessel components. If a Switch Float Extension longer than the included 11/16" Extension is needed, look at the list of available Switch Float Extensions on KENCO Engineering's website.
3. A small container of Thread Locking Compound is included with the KPFS and is used to secure the Switch Float to the Float Arm. In order for the Thread Locking Compound to work properly, it is **important to shake the container thoroughly** before applying it.
4. Apply the Thread Locking Compound liberally to the external threads of the Float Arm. If using a Switch Float Extension, apply the Thread Locking Compound to the external threads of the Switch Float Extension and Float Arm.
5. Install Switch Float Extension and/or Switch Float and tighten hand tight.
6. After the Switch Float is installed, wipe off any excess Thread Locking Compound.
7. To prevent thread galling, Kenco recommends the use of RectorSeal Virgin 100 pipe sealer with Teflon or an equivalent Teflon based pipe sealer. Apply pipe sealer liberally to the 2" NPT process connection threads on the switch.

- Screw the switch into the process vessel hand tight. Tighten at least one full turn beyond hand tight with wrench until switch is level, the pneumatic valve is facing up and the engraved word “TOP” is indeed on top. To make sure switch is in the proper operating position, place a level on the wrench flats. **Note: For proper operation, the KPFS must be installed with the Pneumatic Valve in the twelve o'clock position.**

Plumbing

- For plumbing instructions, refer to Figure 1. When plumbing the valve, use a quality thread sealer. Take care not to use too much sealer since the excess could enter the valve and inhibit proper operation. Connect the supply line to the inlet port of the KPFS valve. If using a KPFS with the –R option (supplied filter/regulator), connect the Kenco regulator to the inlet port of the KPFS valve and the supply line to the inlet port of the filter/regulator. **Note: The pneumatic source must be clean and dry instrument quality air or gas. If dirt and/or moisture are allowed to enter the valve, it could inhibit proper operation.**
- Connect the outlet to the Kenco KDV dump valve or other similar pneumatic device.
- Pressurize system within the rated range of 30-75 psi and check for leaks. If no leaks are found, proceed to check the valve for proper operation.

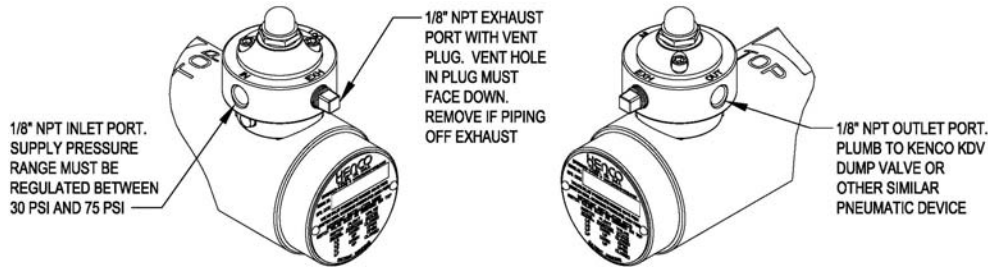

Figure 1

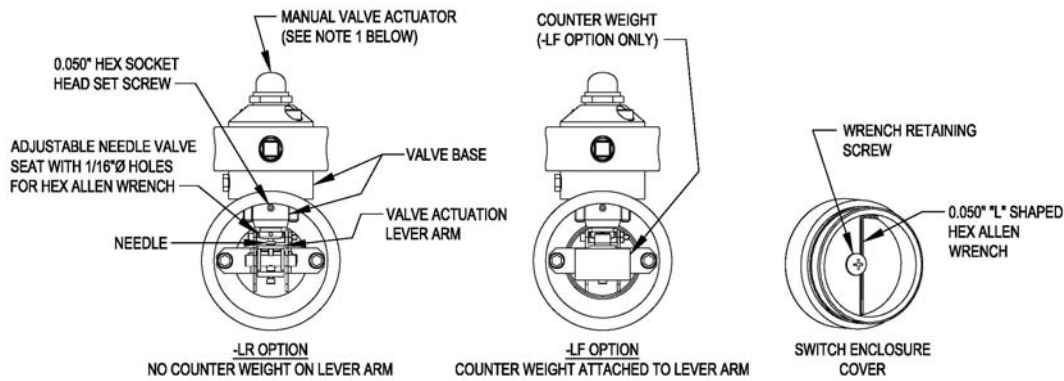

Figure 2

Checking the pneumatic valve for proper operation

- With the valve properly plumbed and pressurized with clean, dry instrument quality air or gas, remove the Switch Enclosure Cover and verify which switch you have by looking at the model number on the tag. It will be either a KPFS-2-LR or a KPFS-2-LF (See the ordering system information on sheet 1 for more details). **Note: Operating the valve with the Manual Valve Actuator does not actuate the Lever Arm! The Manual Valve Actuator operates the valve by manually shifting the valve internally. You will not be able to see any movement from the Lever Arm in the Switch Enclosure when cycling the valve with the Manual Valve Actuator.**
- If your unit is a KPFS-2-LR, use the following instructions to check for proper operation:
 - Verify that the float is in the “down” position (liquid level below the switch centerline). The valve should be closed and the needle valve not bleeding any air/gas. See –LR OPTION in Figure 2.
 - Gently toggle the Valve Actuation Lever Arm by hand. Pushing down on the Lever Arm will shift the valve open. **Be careful here!** Too much force can bend the Lever Arm damaging the switch. A light touch is all that is needed. Releasing the Lever Arm will close the valve.
- If your unit is a KPFS-2-LF, use the following instructions to check for proper operation:
 - Verify that the float is in the “up” position (liquid level above the switch centerline). The valve should be closed and the needle valve not bleeding any air/gas. See –LF OPTION in Figure 2.
 - Note the counter weight bolted to the back of the Lever Arm. Gently toggle the Valve Actuation Lever Arm by hand. Lifting up on the lever arm will shift the valve open. **Be careful here!** Too much force can bend the Lever Arm damaging the switch. A light touch is all that is needed. Releasing the Lever Arm will close the valve.

Valve set up

All Kenco KPFS pneumatic switches are factory set and adjusted for proper operation. No further adjustment should be necessary. If you suspect the valve is leaking at the Needle Valve Seat or is not properly adjusted, the following instructions will explain the recommended adjustment procedure: **Note: For safety reasons, KENCO Engineering recommends the use of air only when setting up the valve. If natural gas is being used as the supply gas, temporarily connect a portable air tank pressurized with air to adjust the switch. Make sure the supply pressure is within the rated range of 30-75 PSI and the air is clean and dry. Once the switch is adjusted, disconnect the portable air tank and reconnect the supply gas.**

- Make sure the Switch Float is in the “Valve Closed” position. On the KPFS-LR model, the Switch Float will need to be in the down position. On the KPFS-LF model, the Switch Float will need to be in the up position. You will know which model you have by the model number on the Switch Enclosure Cover name tag. In addition to this, the KPFS-LF has a counter weight attached to the Lever Arm and the KPFS-LR does not. See illustrations in Figure 2.
- Turn off the supply line pressure to the switch if system is pressurized.
- Remove the Switch Enclosure Cover on the end of the switch body.
- Remove the 0.050” “L” Shaped Hex Allen Wrench from inside the Switch Enclosure Cover by loosening the Wrench Retaining Screw.
- Using the 0.050” “L” Shaped Hex Allen Wrench supplied with the switch, loosen the Hex Socket Head Set Screw located at the 12 o’clock position inside the switch enclosure.

Important: Only loosen the Hex Socket Head Set Screw 1 to 1-1/2 turns.

- The Adjustable Needle Valve Seat is designed to be raised and lowered using the “L” Shaped Hex Allen Wrench supplied with the switch. There are six holes in the seat and you can only turn one hole at a time. It takes six turns to rotate the seat one complete revolution. A good starting point for adjustment is to raise the Needle Valve Seat until it bottoms out against the Valve Base. Insert the long end of the wrench into one of the holes in the Needle Valve Seat and turn it to the right as far as possible before moving the wrench to the next hole.
- Once the Needle Valve Seat is bottomed out against the Valve Base, lower the Needle Valve Seat 6 turns to the left or one complete revolution.

Important: Great care must be taken here. If the Needle Valve Seat is lowered so much that the Lever Arm is in a bind, damage to the Needle and/or Lever Arm can occur. During adjustment, continuously check the movement of the Lever Arm by gently toggling it with your finger to make sure it moves up and down freely. If the Lever Arm does not move up and down freely, the Needle Valve Seat has been lowered too much and has the Lever Arm in a bind. If this is the case, raise the Needle Valve Seat by turning the wrench to the right until the Lever Arm moves freely.

- With this starting point established, pressurize the system somewhere within the 30-75 psig switch pressure range.
- Air should be leaking from the Needle Valve Seat. If it is not, toggle the Lever Arm and/or Switch Float to verify that the valve is shifting properly.

Note: If air is still not leaking from the Needle Valve Seat, raise the seat by turning the wrench to the right until you hear the air leaking.

- While the air is leaking, pay close attention to the sound of the air as it is leaking out.
- Slowly lower the Needle Valve Seat by turning the wrench to the left until you hear the air stop leaking.
- When you hear the air stop leaking, lower the Needle Valve Seat an additional 1 to 1-1/2 turns. This will put the right amount of preload on the Needle Valve Seat to ensure that the valve opens when the Switch Float is level.
- Gently toggle the Lever Arm a few times to make sure it moves up and down freely and to verify that the valve is opening and closing properly.
- Tighten the Hex Socket Head Set Screw.
- Reinstall the Hex Allen Wrench inside the Switch Enclosure Cover and reinstall the Switch Enclosure Cover.
- Your KPFS is now ready for operation.

PRODUCT SPECIFICATIONS

Description		Specification
Specific Gravity		≥ 0.53 (≥0.66 with included 11/16” long Float Extension installed)
Wetted Parts Material	Standard	303/304 SS
	Optional	316 SS
Process Connection Size	Standard	2” NPT
	Optional	1½” NPT (Not yet available)
Temperature Range		-20°F to 257°F (-29°C to 125°C)
Pneumatic Valve Type		3-Way, 2-Position Block and Bleed
Process Pressure Range		Vacuum to 2000 PSI
Pneumatic Valve Supply Pressure		30-75 PSI
Optional Filter/Regulator Supply Pressure		300 PSI Maximum
Optional Filter/Regulator Output Pressure Range		0-160 PSI (Note: Although the Filter/Regulator is capable of higher pressures, it must not be set above the valve maximum supply pressure rating of 75 PSI)