

MODEL FVSF-TH-1.00

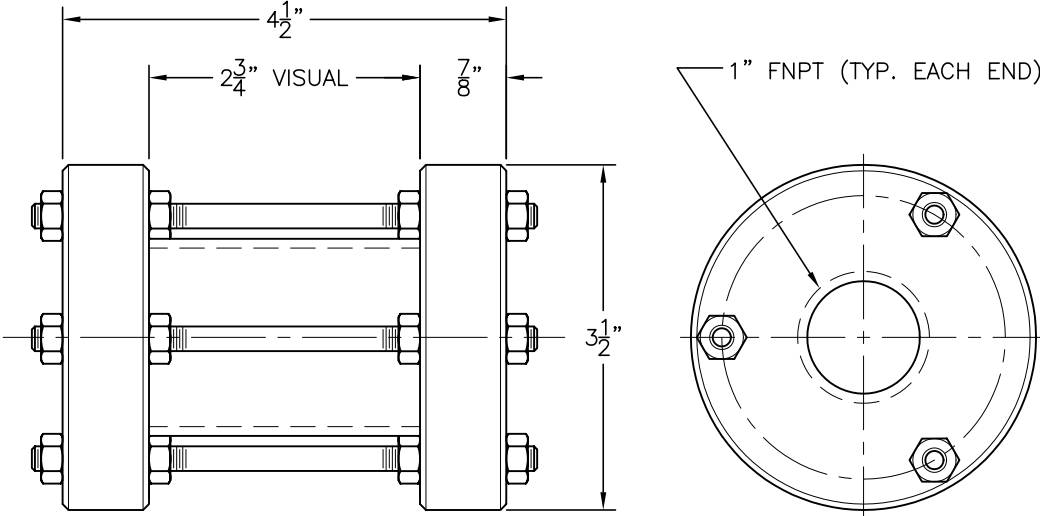

DIMENSION ARE FOR REFERENCE PURPOSES ONLY
AND ARE SUBJECT TO CHANGE AT ANY TIME WITHOUT
NOTICE.

COPYRIGHT © 2003-KENCO INTERNATIONAL, INC.-ALL RIGHTS RESERVED

REV.	DATE	BY	ECN	EXPLANATION:

KENCO ENGINEERING COMPANY TULSA, OKLAHOMA			
INDICATOR, SIGHT FLOW (OUTLINE DRAWING) MODEL FVSF-TH-1.00			
DATE: 02-03-03	SHEET: 1 OF 1	DRAWING NUMBER	
DRN. BY: DPS	CHKD. BY:	C-43654	
SCALE: NONE	REVISION:		