

# MODEL FVSF-F-1.50

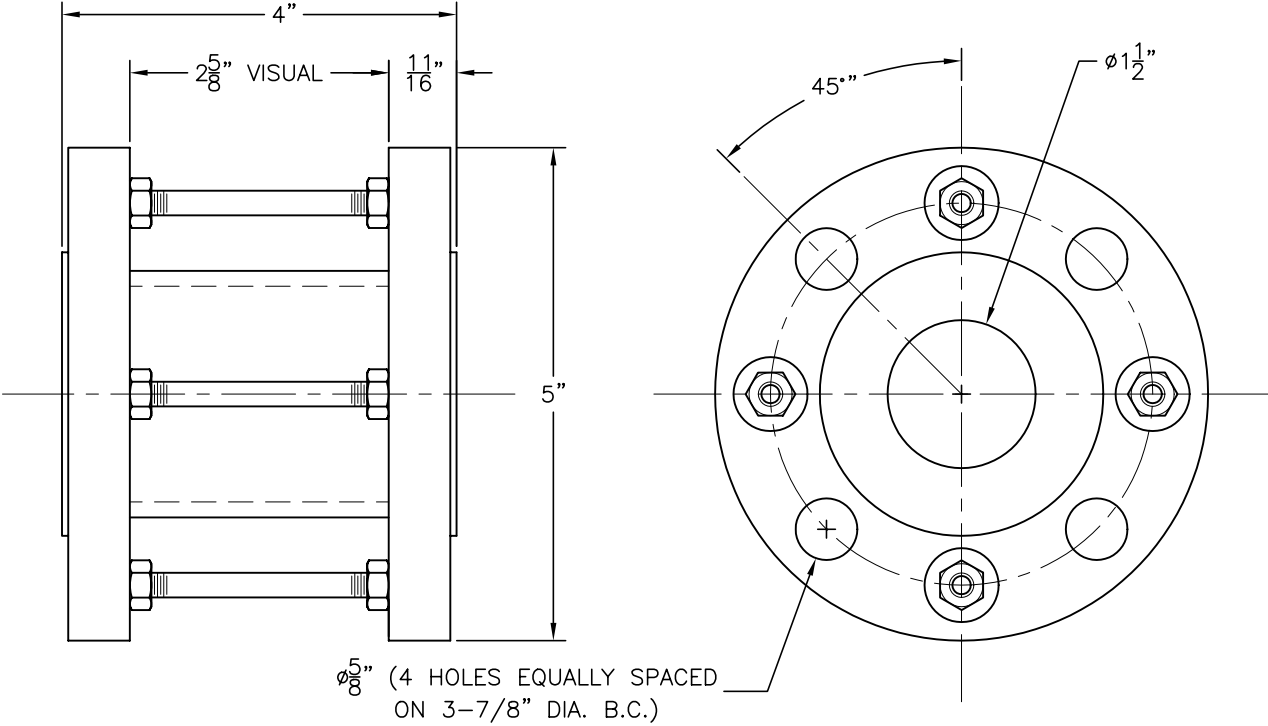

DIMENSION ARE FOR REFERENCE PURPOSES ONLY AND ARE SUBJECT TO CHANGE AT ANY TIME WITHOUT NOTICE.

COPYRIGHT © 2003-KENCO INTERNATIONAL, INC.-ALL RIGHTS RESERVED

REV.	DATE	BY	ECN	EXPLANATION:

KENCO ENGINEERING COMPANY TULSA, OKLAHOMA		
INDICATOR, SIGHT FLOW (OUTLINE DRAWING) MODEL FVSF-F-1.50		
DATE: 02-03-03	SHEET: 1 OF 1	DRAWING NUMBER
DRN. BY: DPS	CHKD. BY:	C-43658
SCALE: NONE	REVISION:	