

MODEL ESP-2.00

MODEL ST-2.00

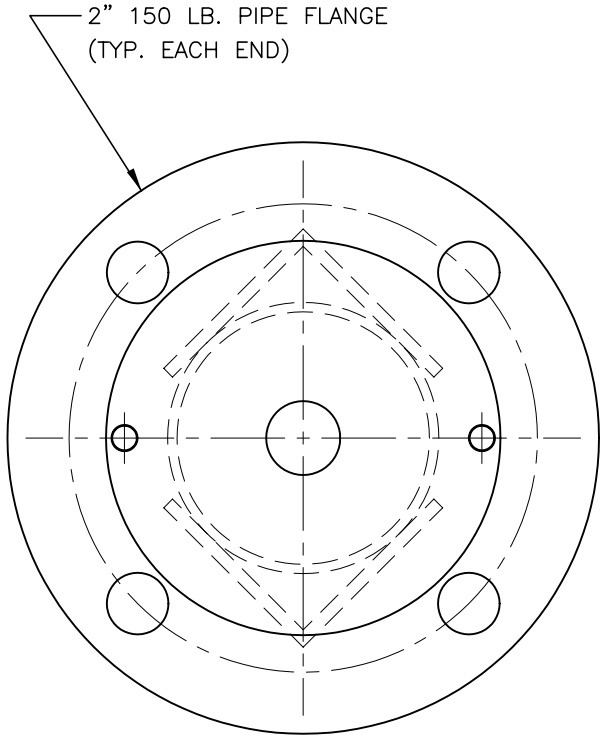
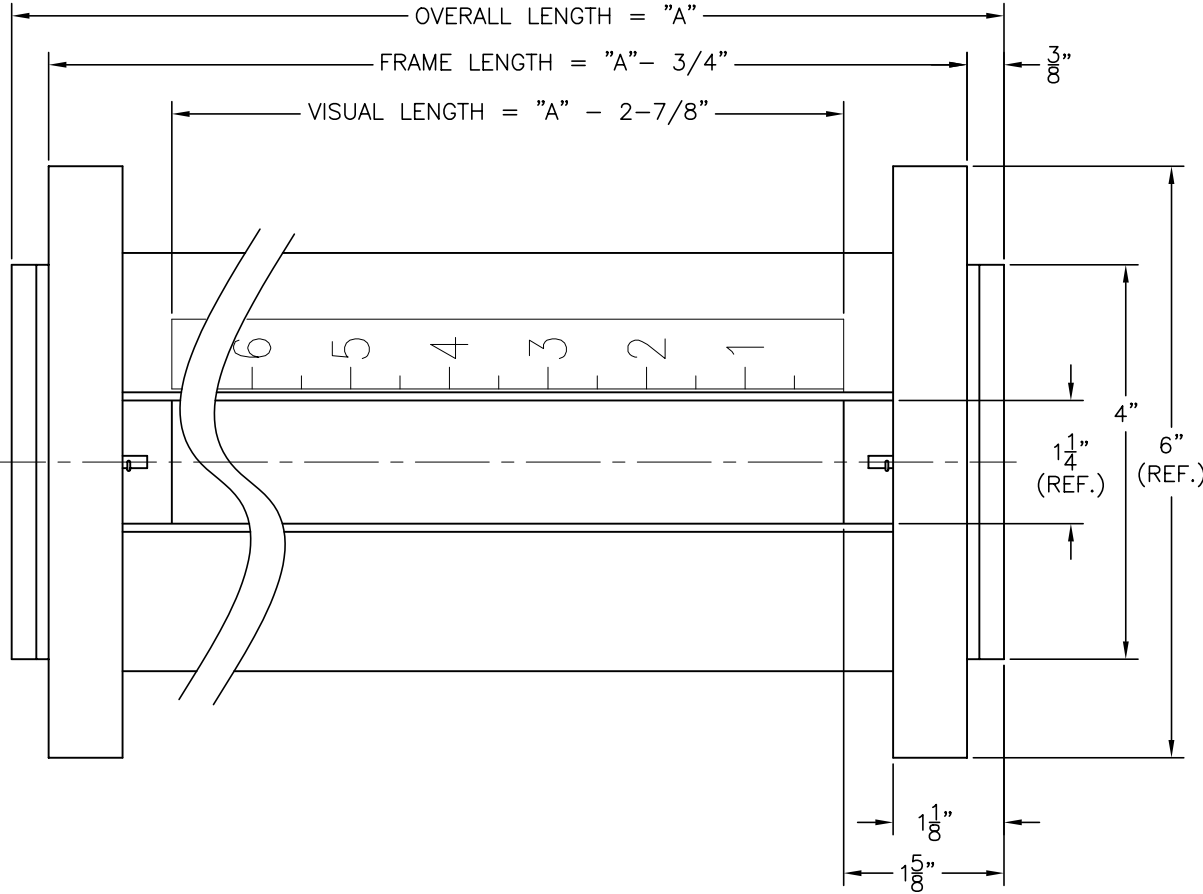

A = LENGTH OF INDICATION (SUPPLIED BY CUSTOMER)

DIMENSION ARE FOR REFERENCE PURPOSES ONLY
AND ARE SUBJECT TO CHANGE AT ANY TIME WITHOUT
NOTICE.

COPYRIGHT © 2003-KENCO INTERNATIONAL, INC.-ALL RIGHTS RESERVED

REV.	DATE	BY	ECN	EXPLANATION:

KENCO ENGINEERING COMPANY TULSA, OKLAHOMA		
GAUGE, LIQUID LEVEL (OUTLINE DRAWING) MODEL ESP-2.00		
DATE: 02-03-03	SHEET: 1 OF 1	DRAWING NUMBER
DRN. BY: DPS	CHKD. BY:	C-43692
SCALE: NONE	REVISION:	