

MODEL ESP-1.00-1.0T

MODEL ST-1.00-1.0T

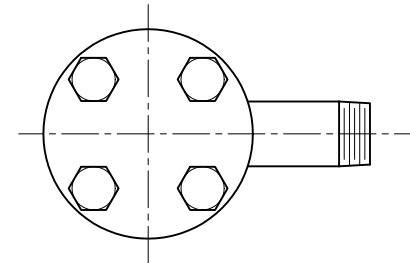
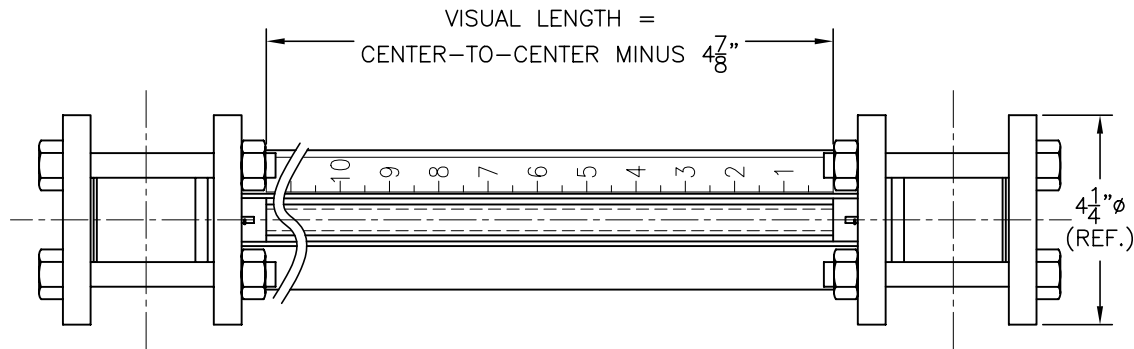
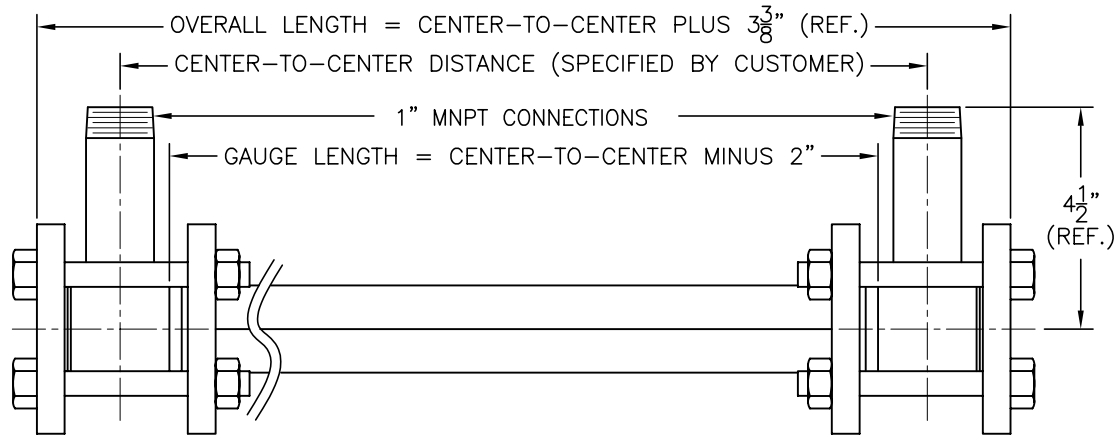

DIMENSION ARE FOR REFERENCE PURPOSES ONLY
AND ARE SUBJECT TO CHANGE AT ANY TIME WITHOUT
NOTICE.

COPYRIGHT © 2003-KENCO INTERNATIONAL, INC.-ALL RIGHTS RESERVED

REV.	DATE	BY	ECN	EXPLANATION:	KENCO ENGINEERING COMPANY TULSA, OKLAHOMA		
					GAUGE, LIQUID LEVEL (OUTLINE DRAWING) MODEL ESP-1.00-1.0T		
					DATE: 02-03-03	SHEET: 1 OF 1	DRAWING NUMBER
					DRN. BY: DPS	CHKD. BY:	C-43752
					SCALE: NONE	REVISION:	