

MODEL ASF-F-1.00

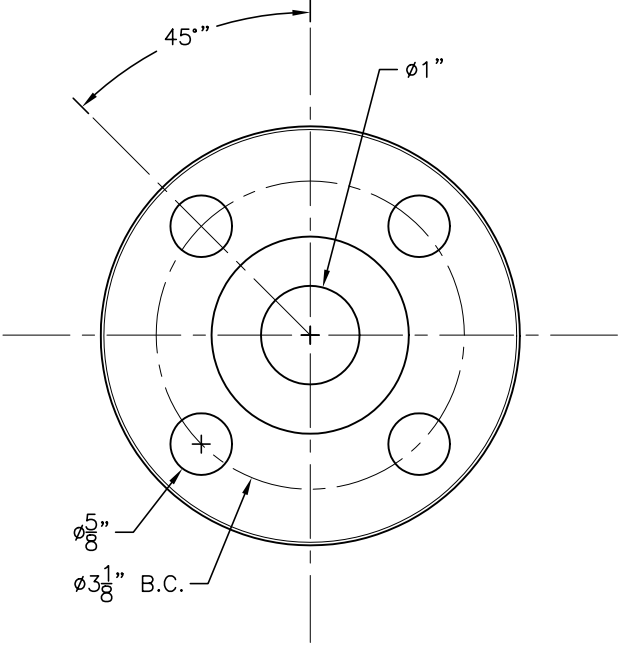
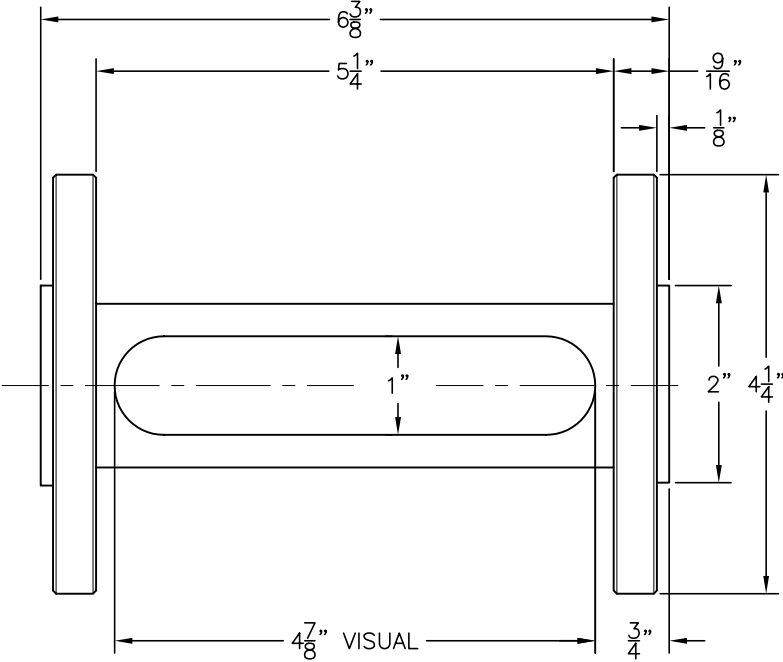

DIMENSION ARE FOR REFERENCE PURPOSES ONLY
 AND ARE SUBJECT TO CHANGE AT ANY TIME WITHOUT
 NOTICE.

COPYRIGHT © 2003-KENCO INTERNATIONAL, INC.-ALL RIGHTS RESERVED

REV.	DATE	BY	ECN	EXPLANATION:

KENCO ENGINEERING COMPANY
 TULSA, OKLAHOMA

INDICATOR, SIGHT FLOW
 (OUTLINE DRAWING) MODEL ASF-F-1.00

DATE: 02-03-03	SHEET: 1 OF 1	DRAWING NUMBER
DRN. BY: DPS	CHKD. BY:	C-43647
SCALE: NONE	REVISION:	